

EDR Series

Model

ECOMaster

Instruction Manual

Rev 2.1

- Thank you for purchasing “EDR Series”.
- To use this unit properly, read this “Instruction Manual” thoroughly before using this unit. Keep this instruction manual around this unit for referring at anytime.



WARNING! :

Carefully read and thoroughly understand the important warning items described in this manual before using this unit.

Contents

1. Cautions in Using with Safety	1
1.1 Explanation	1
1.2 Table of Illustrated Symbols.....	2
1.3 Fundamental Matters of “WARNING!” and “CAUTION!”	3
1.4 Requirements for Installation	4
2. Contents of packing	5
3. Description and Function of Each Part	6
3.1 Main Body	6
3.2 Operation Part.....	7
3.3 Abrasive Unit	8
3.4 Loading Unit	9
3.5 Platen Unit.....	10
3.6 Changer Unit	11
3.7 Pump and Water Recycle Unit.....	12
3.8 Pad Holders	13
4. Set Up	14
4.1 Set up Changer Unit and Power Supply	14
4.2 Set up Water Recycle System	15
4.3 Preparation of Operation	19
4.3.1 Setting spindle.....	19
4.3.2 Turning on the power.....	19
4.3.3 Preparation of Water and Compound	20
5. Operation	22
5.1. Power on.....	22
5.2. Power off.....	22
5.3. Initialization	22
5.4. Select Menu	23
5.4.1 Main menu screen.....	23
5.4.2 Sanding	24
5.5 During operations.....	25

5.6 During a pause	25
5.7 Check.....	26
5.7.1 Running total	26
5.7.2 Warning	29
5.7.3 Repair history	29
5.8 Error Messages.....	30
5.9 Error List.....	31
6. Maintenance.....	33
6.1 Supplement Compound.....	33
6.2 Supplement Water.....	33
6.3 Daily maintenance.....	33
6.4 Weekly maintenance	37
7. Caution	37
8. After Service.....	38
9. Specifications	38
10.Wiring Diagram	39
11. Replacement Parts.....	41
12. Warranty.....	42



1. Cautions in Using with Safety

1.1 Explanation

<MEANING OF ILLUSTRATED SYMBOLS>

Illustrated Symbols

Various symbols are used in this safety manual in order to use the unit without danger of injury and damage of the unit. A list of problems caused by ignoring the warnings and improper handling is divided as shown below. Be sure that you understand the warnings and cautions in this manual before operating the unit.

	WARNING!	If the warning is ignored, there is the danger of a problem that may cause a serious accident or even fatality.
	CAUTION!	If the caution is ignored, there is the danger of a problem that may cause injury/damage to property or the unit itself.

Meaning of Symbols



This symbol indicates items that urge the warning (including the caution).
A detailed warning message is shown adjacent to the symbol.





This symbol indicates items that are strictly prohibited.
A detailed message is shown adjacent to the symbol with specific actions not to perform.





This symbol indicates items that should be always performed.
A detailed message with instruction is shown adjacent to the symbol.

1.2 Table of Illustrated Symbols

I Warning

		
Warning, Generally	Warning, High voltage	Warning, High temperature



I Caution

		
Caution, Generally	Caution, Rotation	Caution, Finger

I Prohibit

		
Prohibit, Generally	Prohibit, To disassemble	Prohibit, To touch

I Compulsion

		
Compulsion, Generally	Compulsion, Disconnect the power plug	Compulsion, Connect to the grounding terminal

1.3 Fundamental Matters of “WARNING!” and “CAUTION!”



WARNING!



Do not use this unit in an area where there is flammable or explosive gas

Never use this unit in an area where there is flammable or explosive gas. This unit is not explosion-proof. An arc may be generated when the power switch is turned on or off, and fire/explosion may result.



Always ground this unit

Always ground this unit on the power equipment side in order to avoid electrical shock due to a power surge.



If a problem occurs

If smoke or strange odor should come out of this unit for some reason, turn off the power switch right away. Immediately contact a service technician for inspection. If this procedure is not followed, fire or electrical shock may result. Never perform repair work yourself, since it is dangerous not recommended.



Do not use the power cable if it is bundled or tangled

Do not use the power cable if it is bundled or tangled. If it is used in this manner, it can overheat and fire may be caused.



Do not process, bend, wring, or stretch the power cable forcibly

Do not process, bend, wring, or stretch the power cable forcibly. Fire or electrical shock may result.



Do not disassemble or modify this unit

Do not disassemble or modify this unit. Fire or electrical shock or failure may be caused.



CAUTION!



During a thunder storm



During a thunderstorm, turn off the power switch immediately. If this procedure is not followed, fire or electrical shock or failure may be caused.

1.4 Requirements for Installation



WARNING!

1. Always ground this unit

-   Connect the power plug to a receptacle grounded.
- Do not forget to ground this unit, to protect you and the unit from electrical shock in case of power surge. Choose a receptacle with grounding connectors as often as possible.
- Do not connect the grounding wire to a gas pipe, or by means of a lightning rod or telephone line. A fire or electrical shock will occur.

2. Choose a proper place for installation

-  Do not install this unit in a place where:
 - ⌘ Rough or dirty surface.
 - ⌘ Flammable gas or corrosive gas is generated.
 - ⌘ There is direct sunlight.
 - ⌘ There is excessive humidity and dust.
 - ⌘ There is constant vibration.

3. Do not modify

-  Modification of this unit is strictly prohibited. This could cause a failure.

4. Installation on horizontal surface

-  Set this unit to the flattest place.



CAUTION!

5. Use a correct power receptacle

- Use a correct power receptacle that meets the unit's rated electric capacity.

Electric capacity:

ECOMaster : 100 – 240 VAC, 50/60Hz, 250W(Max)

2. Contents of packing

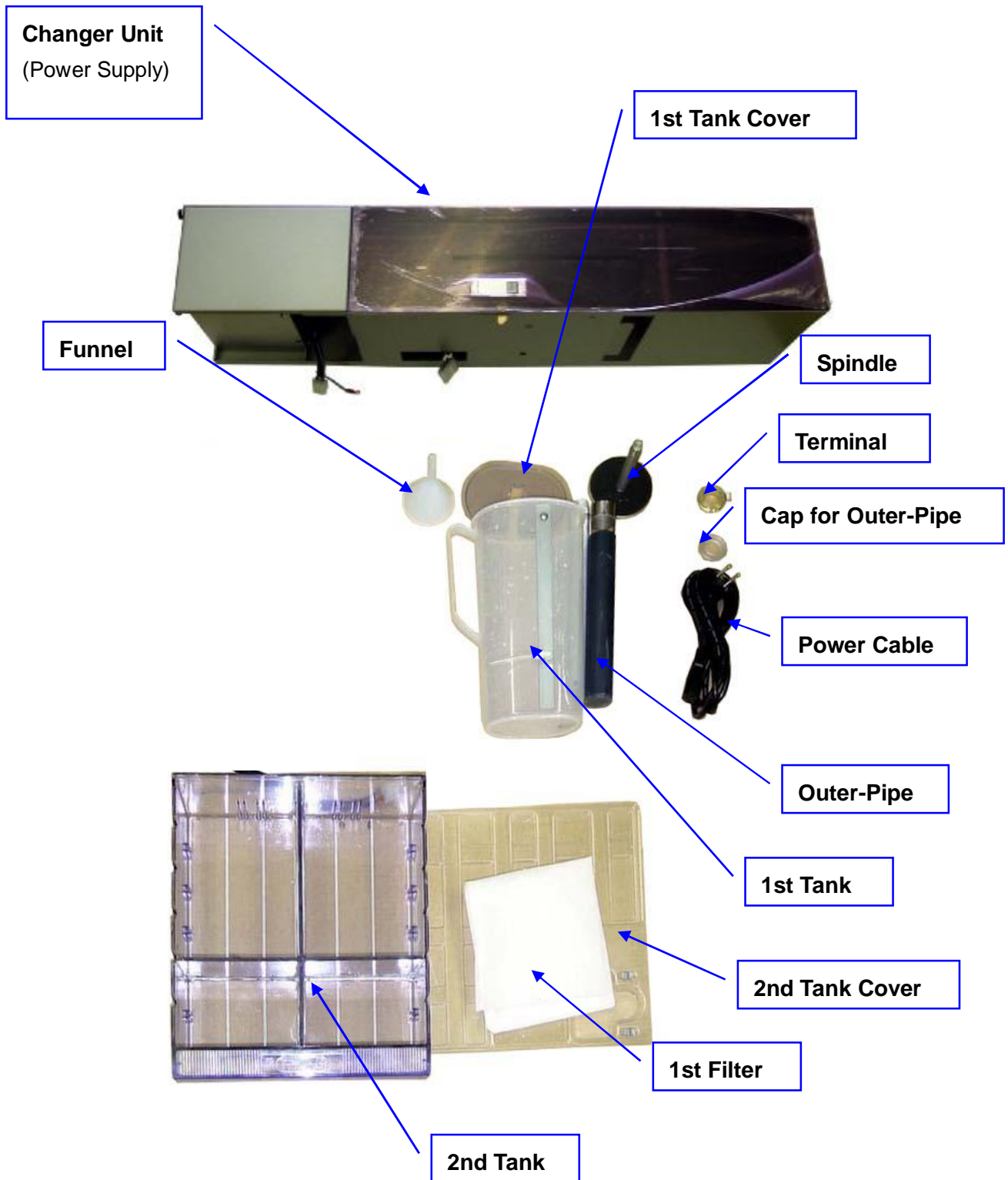

3. Description and Function of Each Part

3.1 Main Body



1	Hatch Handle	Open in case of changing Pad except for processing.	
2	Front Door	Open in case of changing Water recycle parts.	
3	Casters	Used to move the Main Body. Be sure to lock it before operation.	
4	Hinges	Used to install a Changer Unit.	
5	Changer Connector	Connecting to Changer Connector.	
6	External Connectors	6-A	Power supply Input
		6-B	RS-232C communication unit
		6-C	Ethernet unit
		6-D	Option Output.

3.2 Operation Part

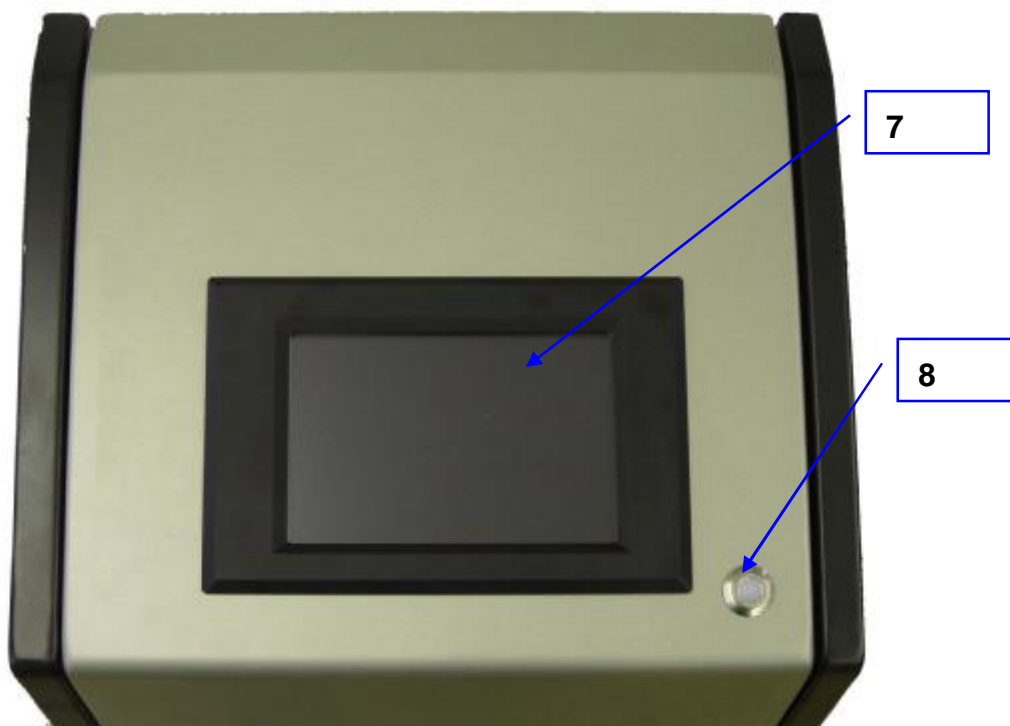

7	LCD with Touch Panel	The menu of operations and the condition of the machine are displayed in it. Don't operate it with sharp things.
8	POWER/PAUSE Switch	It is used to turn on and off unit power and push it when you want to stop automatic operations of the machine.

3.3 Abrasive Unit

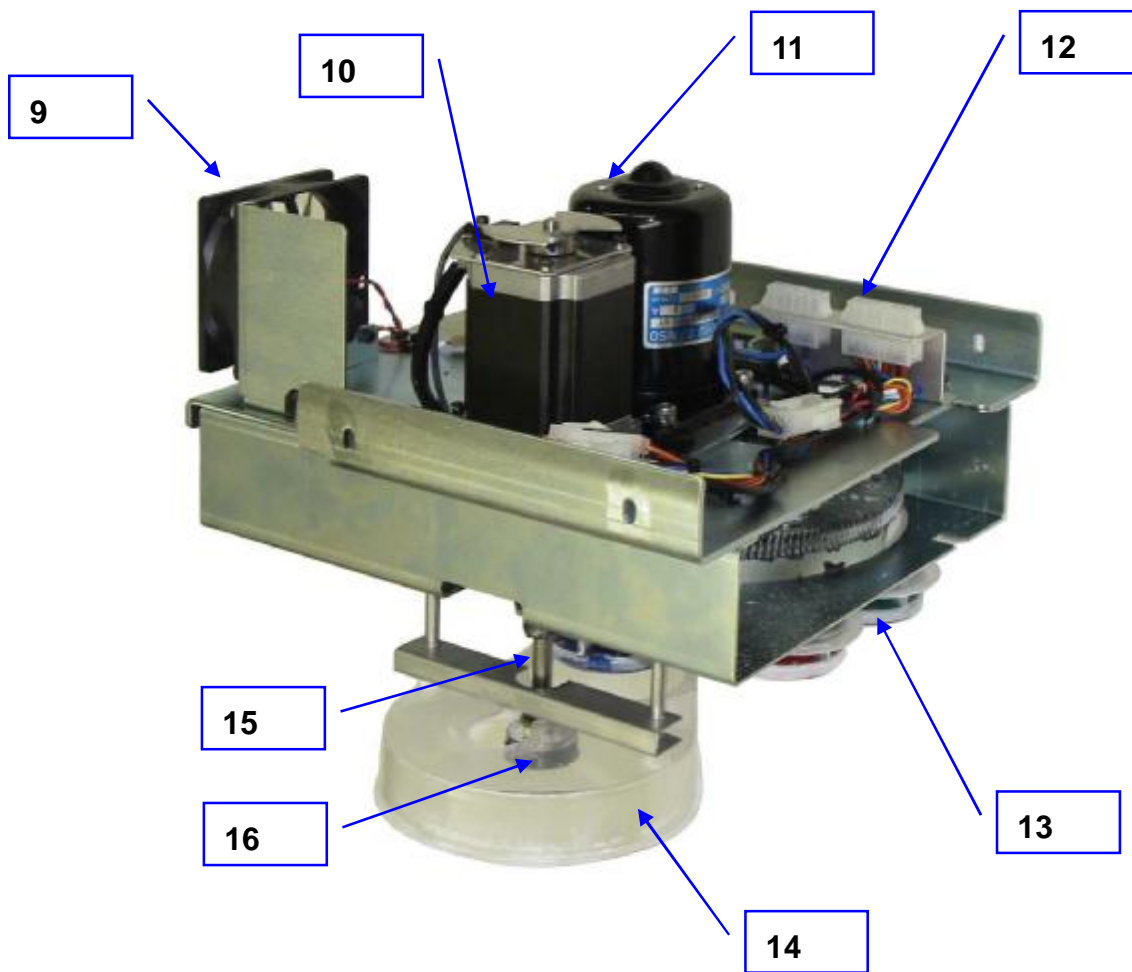

9	Cooling Fan	For cooling Motors and other parts.
10	Platen Motor	Motor drives Turn Table.
11	Sanding Motor	Motor drives Pads.
12	Abrasive Connectors	Connected to Main Board.
13	Pads	5 different type of Pads
14	Splash Cover	Cover protects to splash water during process.
15	Turn Table Drive Shaft	Shaft drives Turn Table.
16	Center Rubber	Protect the center of disc from going through water and compound.

3.4 Loading Unit

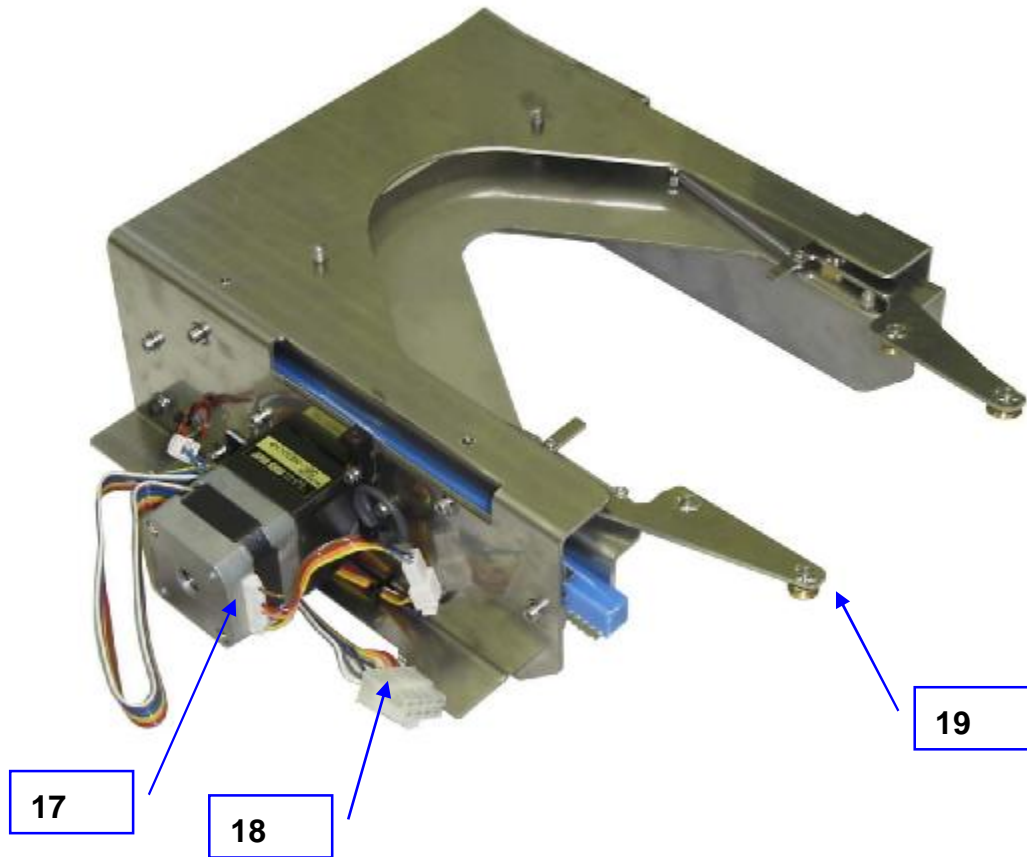

17	Loading Motor	Motor drives Grabs front and rear horizontally.
18	Loading Connector	Connected to Main Board.
19	Grabs	Grabs catch and carry a disc.

3.5 Platen Unit

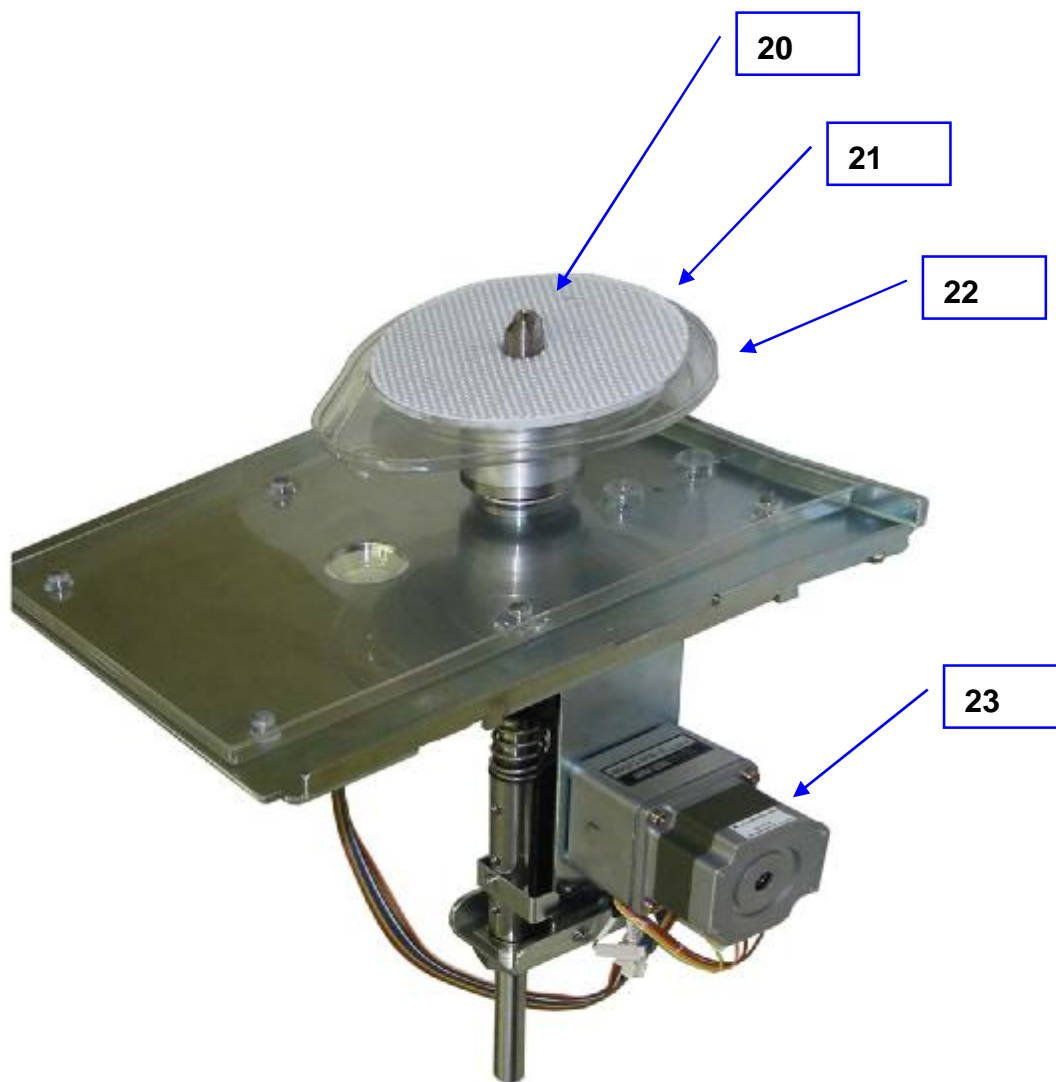

20	Center Pin	It fixes Turn Table.
21	Turn Table	It fixes disc during process.
22	Under Splash Cover	Collect drainage water.
23	Lift Motor	Motor drives Turn Table up and down vertically.

3.6 Changer Unit

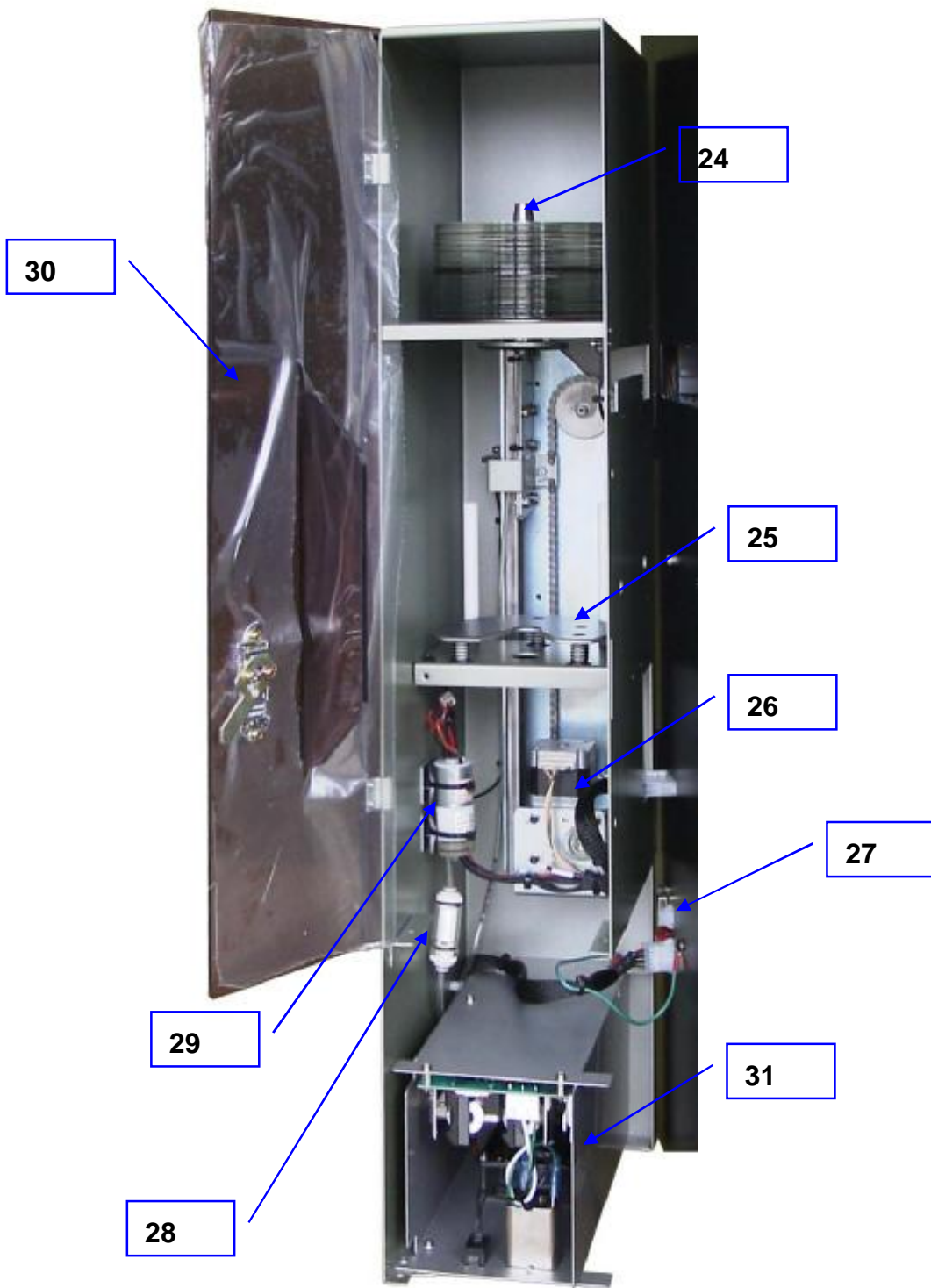

24	Spindle	Repaired Disc is stored in it.
25	Stocker	Not repaired discs are in this space.
26	Changer Motor	Motor drives changer up and down vertically.
27	Changer Connector	Connected to Main Board.
28	Vacuum Filter	To protect vacuum pump from dust in air tube.
29	Vacuum Pump	For picking up disc.
30	Changer Door	Close and lock this door when Changer motor is moving.
31	Power Supply	Main Power Supply for this machine.

3.7 Pump and Water Recycle Unit

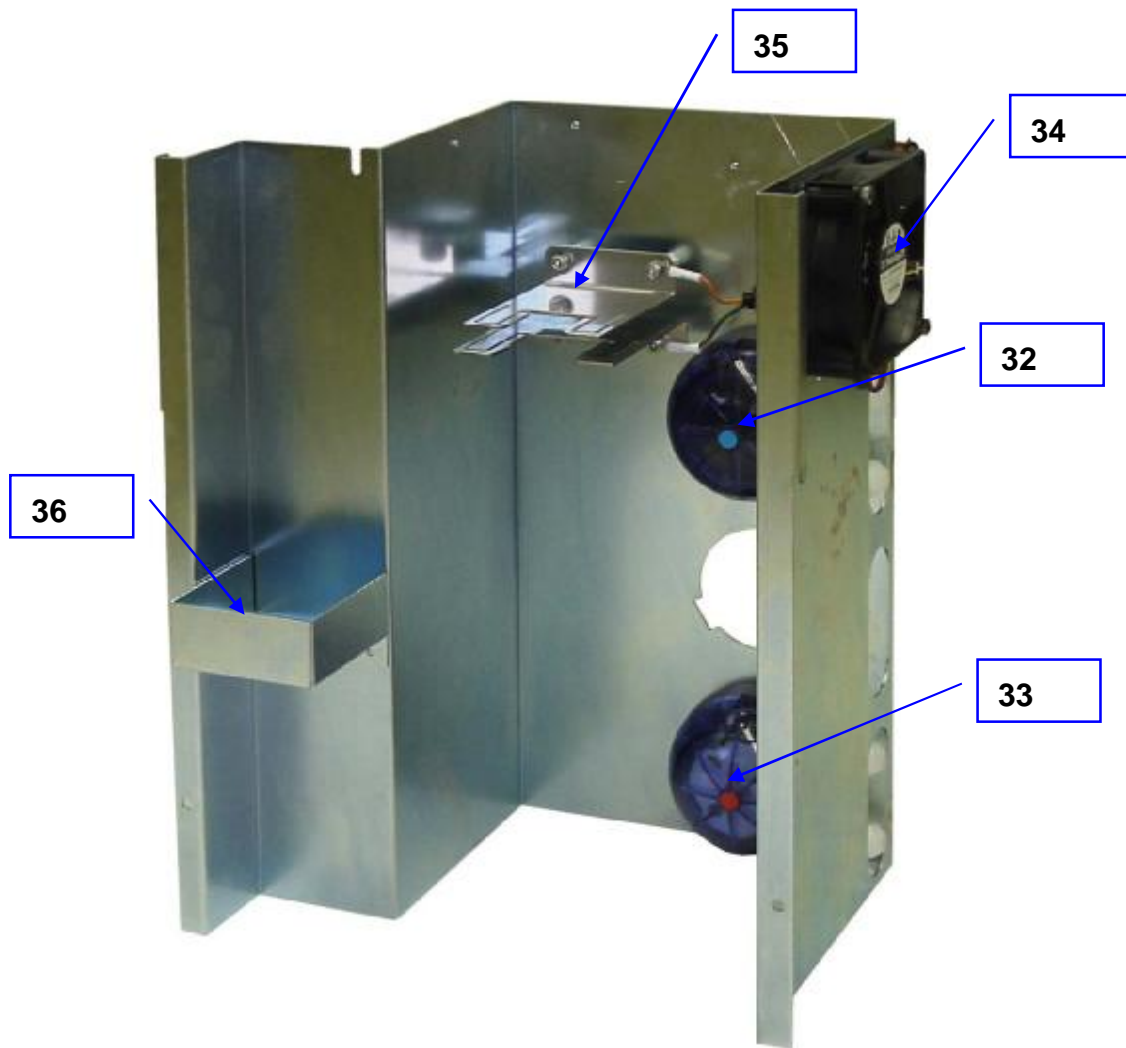

32	Compound Pump	It supplies Compound.
33	Water Pump	It supplies Water.
34	Exhaust Fan	Exhaust fan for vapor from water Recycle System.
35	Terminals	Terminal to put voltage between AI-Pipe to Outer-Pipe.
36	Tank Holder	The place of setting Compound Tank.

3.8 Pad Holders

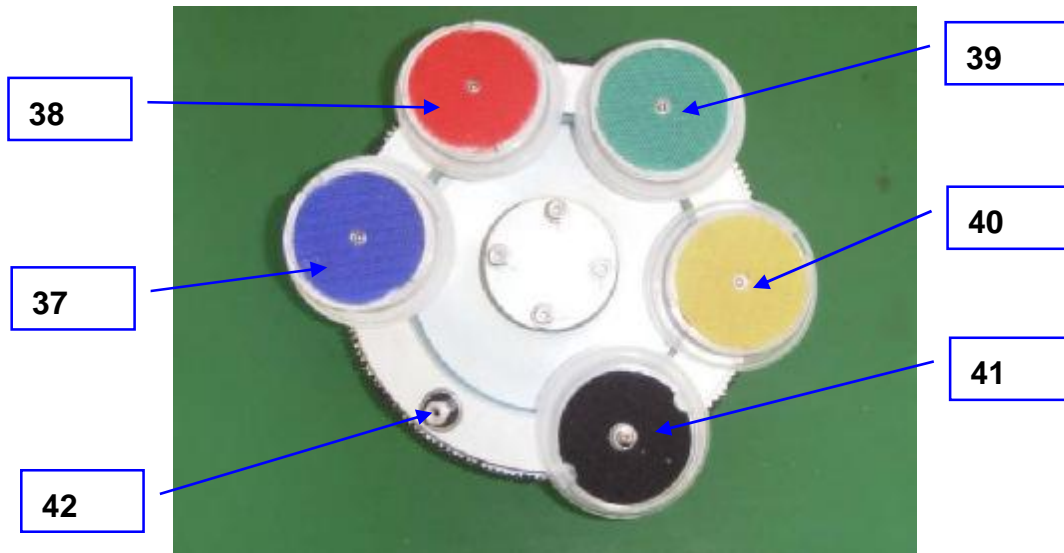

37	#5 Blue Pad Holder	Use with Blue Pad.
38	#4 Red Pad Holder	Use with Red Pad.
39	#3 Green Pad Holder	Use with Green Pad.
40	#2 Yellow Pad Holder	Use with Yellow Pad.
41	#1 Black Pad Holder	Use with Black Pad.
42	For Spare Pad	

4. Set Up

4.1 Set up Changer Unit and Power Supply



1) Insert each Hinge on Changer into both of Hinges on the Main Body referring to the picture, respectively.

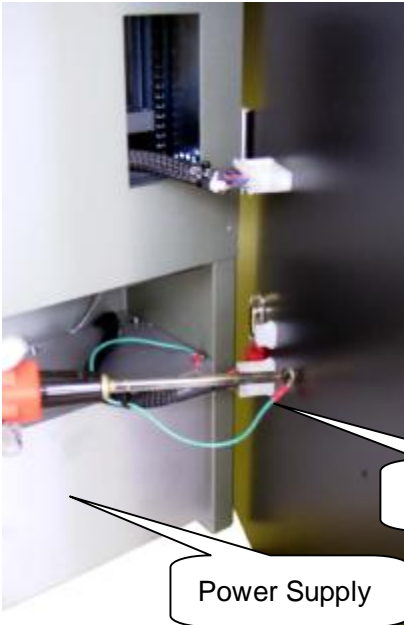

2) Be sure to connect the connectors firmly. Ground wire has to be connected the Main Body with Screw.

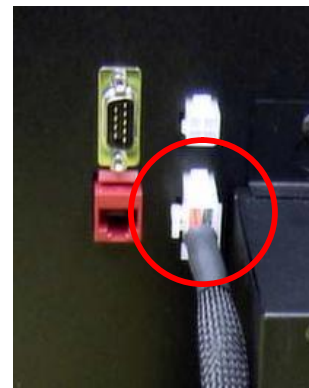

3) Close Changer with lifting it lightly. Then, fix it with two Changer Lock Screws.

4.2 Set up Water Recycle System



1) Set a 1st filter in the 1st tank.



2) Set an Outer-Pipe with the Reactive Pipe inside the cover.



3) A terminal is fixed to the Inner-Pipe with a terminal fixed screw.
And put the funnel on the Inner-Pipe.



4) Prepare a bucket with 5-liter water and “Solution D”.

Make Polish Water in the bucket with water and “Solution D”.

“Solution D”(100ml) is including in “Starter Kit”.

We recommend using mineral water (Soft Water) to get a stable quality

 **CAUTION!**

<Mixture ratio>

“Water” 5 liter: “Solution D” 25 milliliter

If you make it using another ratio, we can't assure quality of disc repair.



5) Put in “Solution D” into water and stir well. (This is Polish Water)

6) Put in Polish Water into the 2nd Tank.

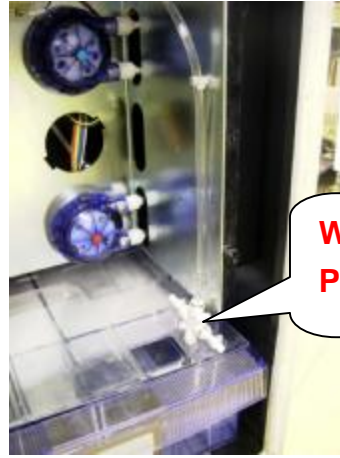

- 7) Put a cover on 2nd Tank and set into Main Body.
- 8) Set a Water Supply pipe to 2nd Tank.



- 9) Set a 1st Tank on 2nd Tank.
Make sure that Terminals has to be connected firmly.



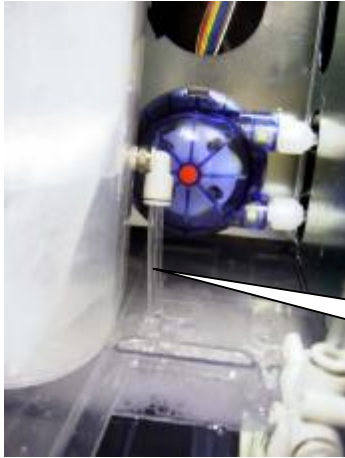

10) Set a Drainage Pipe to 2nd Tank.

Drainage Pipe



Tank Holder

11) Pour over 200 ml of Compound into Compound Tank and set it in Tank Holder.



12) Close a hatch firmly

4.3 Preparation of Operation

4.3.1 Setting spindle



Please set a spindle in Changer.

4.3.2 Turning on the power



Turn on the Power Switch.
Power on side is Operator side.



Turn on the POWER/PAUSE switch.
It is OK that Red LED in switch is ON
after pushing this switch a few seconds
later.

CAUTION!

Please keep Switch OFF time in minimum 10 seconds, before turning on the power again.

If Red LED doesn't ON, wait over 1 minute with Power Switch OFF.

4.3.3 Preparation of Water and Compound



Turn on a compound pump and a water pump until a compound and water appear from nozzles.

* Use a cup or papers to catch compound and water.

<How to operate water and compound pump>

Push here

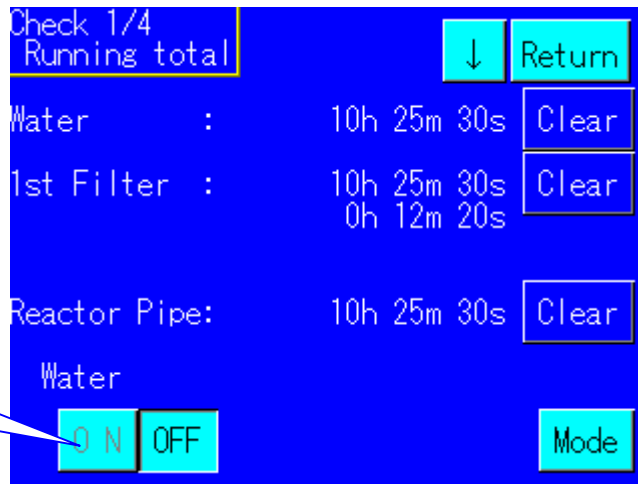

Push here
(Water pump)

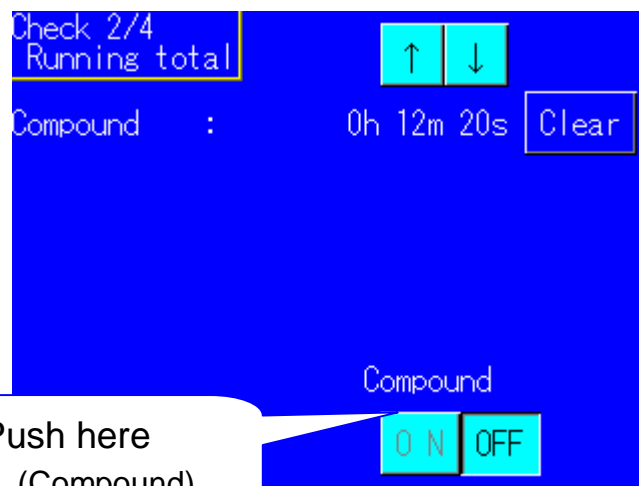

Push here
(Compound)

5. Operation

In this chapter it explains how to operate this machine, and contents in that.

5.1. Power on

After turning on POWER/PAUSE Switch, it is displayed until the machine starts initialization.

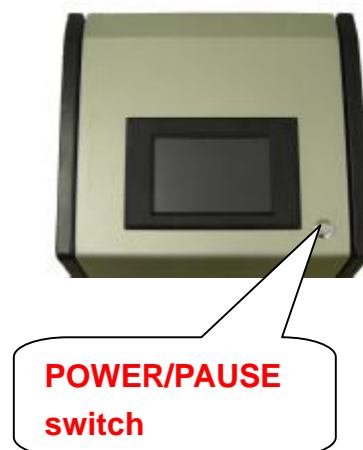
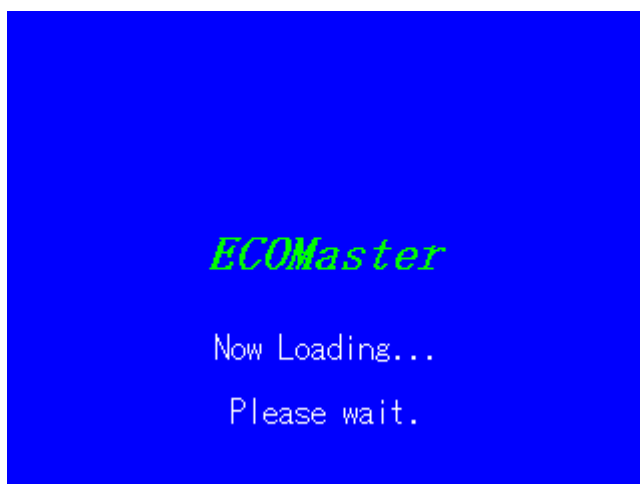

5.2. Power off

Machine shuts down the power by pushing POWER/PAUSE switch during 3 seconds with Main menu screen.

When emergency, turn off the Power supply switch directly.

5.3. Initialization

The initialization of the machine is done for self - checking when a power supply is turned on or each error occurs. Messages below are displayed during initialization. Then, the menu for operations will be displayed.



5.4. Select Menu

5.4.1 Main menu screen

The menu for operations is displayed after initialization. Select Disc and mode, and touch the “Start” after setting of discs in Changer. The machine will start to repair discs. Several messages (demands for renewing of water, Filters, and Pads, etc.) are displayed in “Message Display”. You won’t be able to start operations if the messages are displayed there.

***Operations will be terminated compulsorily in case of no detection of disc even though three times trying to pick up disc in Changer.**

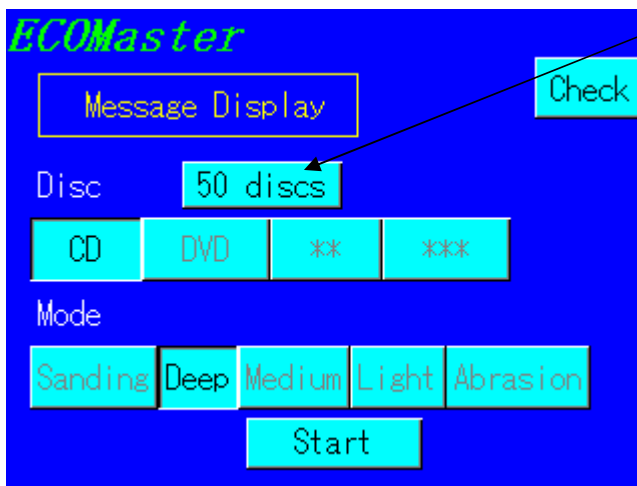

Process number of discs:
Number of discs to deal with can be set up.
Push the part of the number when you change it. (Rev 2.0)

<Disc>

“CD”: It is selected to repair CD. (Low Density Disc)

“DVD”: It is selected to repair DVD. (High Density Disc)

Using “DVD”, “Sanding” and “Deep” mode is prohibited.

<Mode>

Mode	Description
Sanding	Uses the disc that has heavy gouges, not being repaired in “Deep” mode. In this mode the Disc is sanded roughly, finishing process isn’t done. So polish it in “Deep” mode again.
Deep	Uses the disc that has gouges.
Medium	Uses the disc that has scratches
Light	Uses the disc that has light scratches.
Abrasion	It is selected to remove stains from a disc.

“Check”: When you need to check several states of the machine, for example, states of water, Filters, and Pads, push here. (See 5.6.Check)

“Start”: The machine starts operations when you touch this.

5.4.2 Sanding

The below screen is displayed when you touch “Start” in “Sanding” mode. The machine starts operations when you select sanding level and touch “OK”.



“Level 3”: Discs are sanded three times as hard as “Level 1”.

“Level 2”: Discs are sanded twice as hard as “Level 1”.

“Level 1”: Discs are sanded as hard as “Deep” mode.

5.5 During operations

The number of discs, the phase of repairing process, and the state of each process are displayed during automatic operations.

Push POWER/PAUSE Switch if you want to pause.

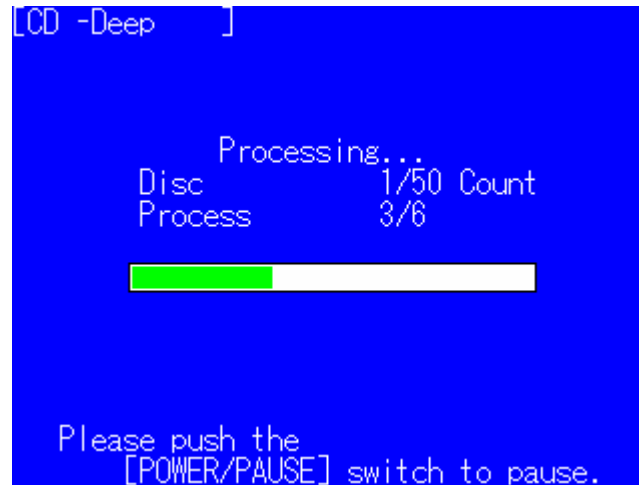

5.6 During a pause

Repairing will be resumed if "Continue" is touched. Operation will be terminated compulsorily regardless of the phase of repairing process if "End" is touched.



5.7 Check

You will see below screens if you touch “Check” in Menu.

5.7.1 Running total

Total work time of each item is displayed. If something needs to exchange, “Clear” will turn black and white. Be sure to display these screens and touch “Clear” of each part after renewing it. Repairs may not be done normally without touching “Clear” after exchanges, so be sure to clear.

Work the machine to confirm the motion of that after renewing Water or Filters. Do the same after supplying Compound.

Touch “↓ ” button to go to next page, and “↑ ” button to go to previous page.

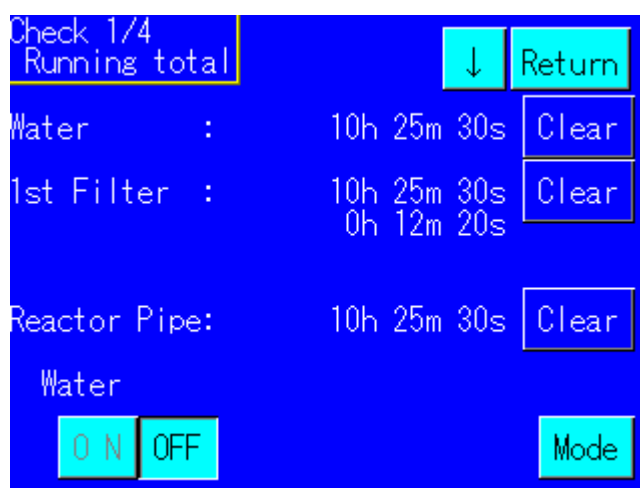

***1st Filter has two timers. If either of them reaches limit, you have to renew 1st Filter and clear it.**

“Mode”

Pushing by this button, and it is possible that a setup of Mode is changed.

Automatic Power OFF Mode

ON: The power supply is cut off automatically when process is completed and an error doesn't occur.

OFF: The power supply is not cut off automatically.

Cartridge Retry Mode

ON: Picking up action will be 3 Times even if disc was not caught.

OFF: Picking up action will be 1 Time

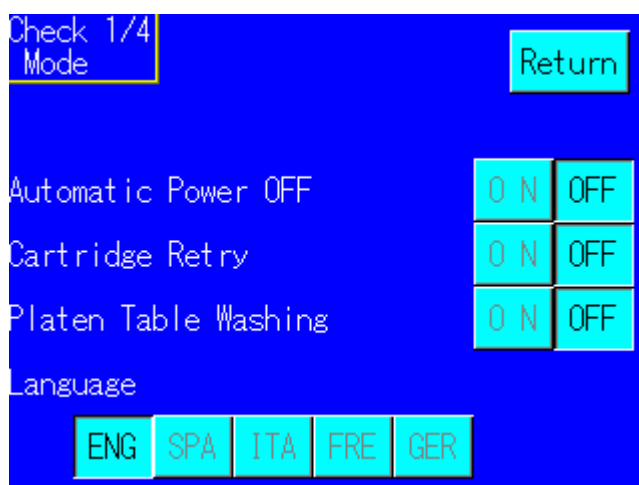

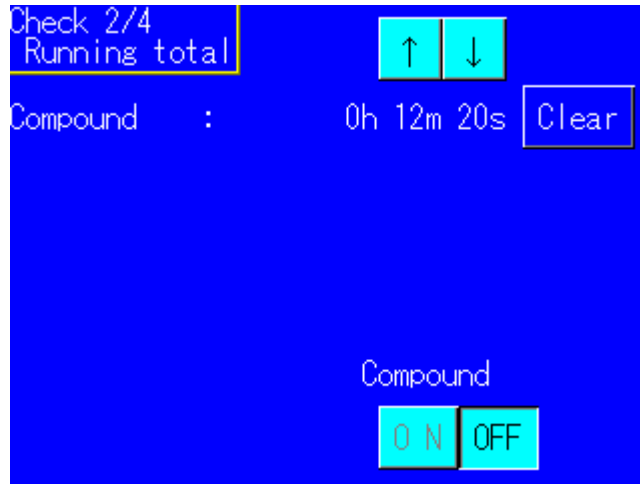

When you want to work Water Pump, Compound Pump, touch “ON” to start and “OFF” to stop them.

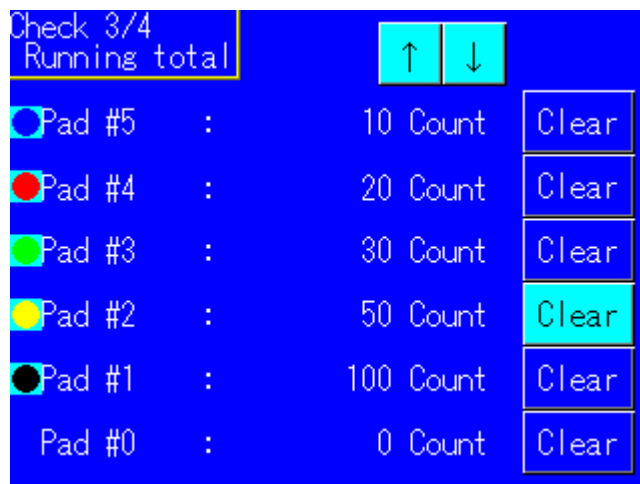

5.7.2 Warning

“Warning” screen will be displayed if “Clear” of each item is touched. Touch “OK” when you want to clear the item selected, and “Cancel” when you don’t.

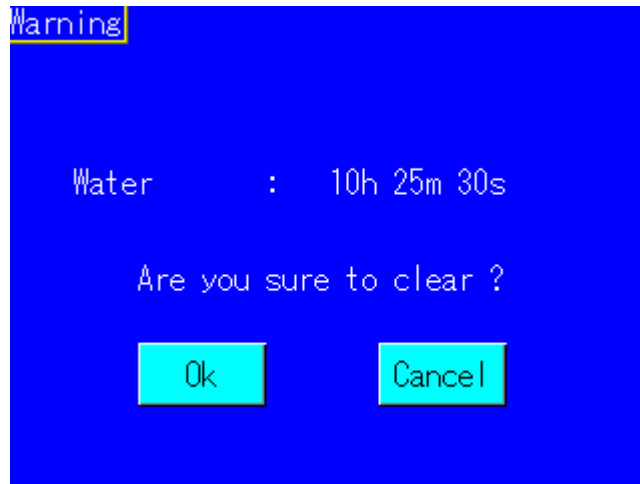

5.7.3 Repair history

Total number of Discs repaired is displayed each kind of Disc and mode, respectively.

*You can't clear these counts.

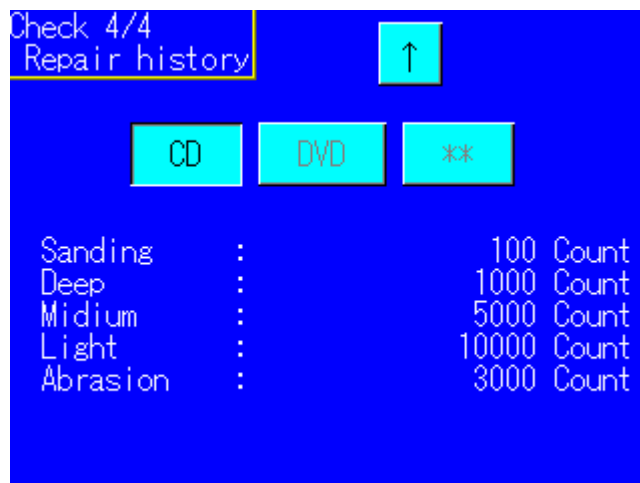

5.8 Error Messages

They are displayed when each error with the machine happens.

Push the [POWER/PAUSE] Switch after the trouble is settled.

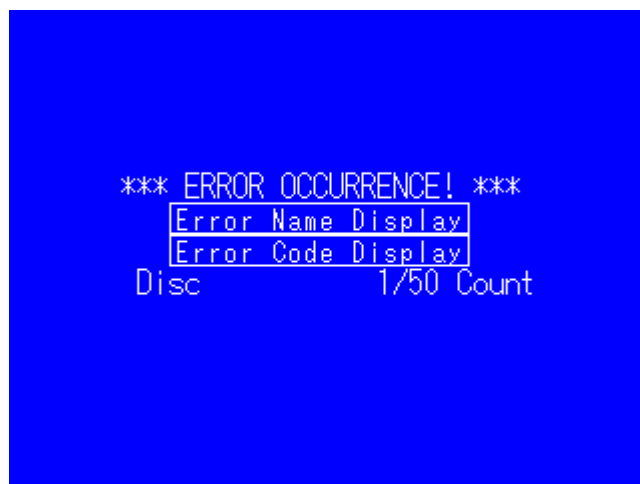

CAUTION!

In the Error occurs often, please note ERROR CODE number and contact the sales agency that unit was purchased.

5.9 Error List

Error	Cause	How to clear errors
Turret Position	Turret Motor doesn't move or there is something to disturb turret rotation.	Check there is nothing to disturb Turret rotation. (Ex. gears, Splash Cover)
Grabs Position	Grabs position is unusual.	If Grabs have the disc incorrectly, remove the disc.
Disc Out Cartridge	A disc is out from Cartridge.	Open the Changer Door and set discs on Stocker rightly.
Disc Loading	Grabs don't catch a disc rightly.	If Grabs have the disc incorrectly, remove the disc.
Disc Release	Grabs don't set a disc on Platen table.	Remove the disc and clear the error.
Splash Cover	There is no Splash Cover or Splash Cover doesn't go down smoothly.	If there is no Splash Cover, set it. If Splash Cover doesn't go down smoothly, check what disturb it going down and remove it.
Platen Lift Position	Platen original position is not searched.	Clear the error. If the error happens again, call service person.
Cartridge Position	Cartridge original position is not searched.	Check Changer Connector is connected firmly. Open the Changer Door and check inside unit there is something to disturb Cartridge or not.
Disc Unstoring	Grabs don't return a disc into Cartridge.	If Grabs have the Disc incorrectly, remove the disc.
Any Disc Release	There is no disc on Turn Table during process.	Check there is no disc on Turn Table and clear the error.
No Sanding Pad	There are no Pads on Pad Holder.	Set pads.
Disc Unloading	Grabs don't catch a Disc from Turn Table.	If Grabs have the disc incorrectly, remove it.
Sanding Motor Over Load Wire Down Non Stop Not Ready Ready	Sanding Motor doesn't work normally.	Clear the error. If the error happens again, call service person.
Platen Motor Turn Lock	Platen Motor doesn't work normally.	Clear the error. If the error happens again, call service person.
Turret Sensor	Turret Sensors don't turn on/off.	Clear the error. If the error happens again, call service person.
Sanding Pressure Lack	Sanding pressure is unusual.	Change Pads.

Water Leaking	Water leaks from Splash Covers.	Clean Under Splash Cover and all Splash Covers.
EEPROM Initialize Error Load Error Verify Error Write Error Reload Error Over writing Error SYSTEM Error	Program doesn't work usually.	Turn OFF and ON Power SW. Don't turn OFF and ON Power SW quickly.

6. Maintenance

6.1 Supplement Compound

Supplement Compound when Compound Adding message appears on Main menu Screen. Confirm that over 200cc of it the Compound Tank before operation.

CAUTION!

If the supplement of Compound is too late and air goes into the Compound tube, pump out the air from it completely. If there is the air in it, you might get but finishing disc or a broken one in worst.

6.2 Supplement Water

The height of Polish Water has to be over top of Water Supply Pipe. (Lower Level)

Make sure that confirm the height of Polish Water before operation.

Abrasion without supplying Polish Water makes disc and Pads damages.

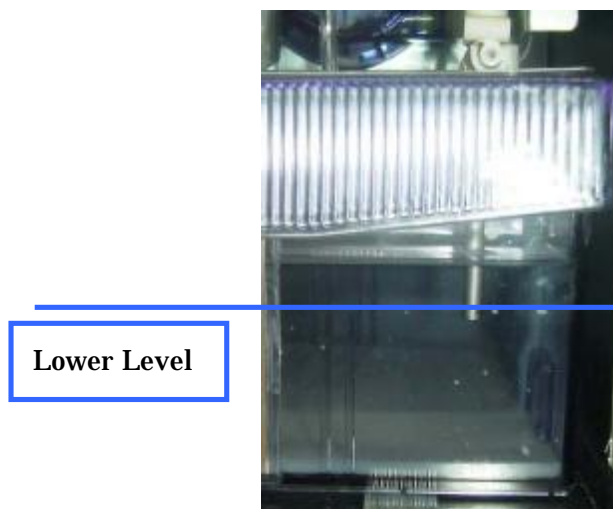

6.3 Daily maintenance

1) Drainage Pipe has to be turned toward Up-side.

Remove 1st Tank with pulling the handle.

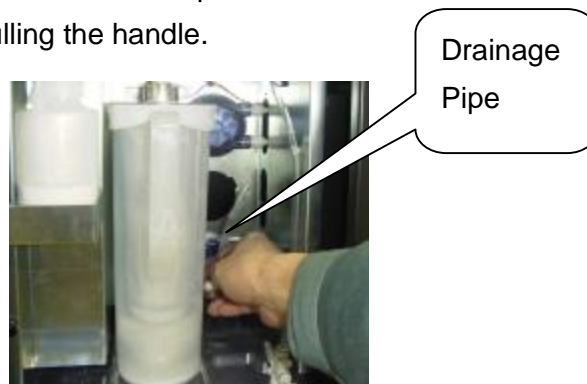

2) Remove Pipe set and 1st Filter with 1st Tank Cover.



3) Pull out the Reactive-pipe from Outer-Pipe by loosening the small screw.

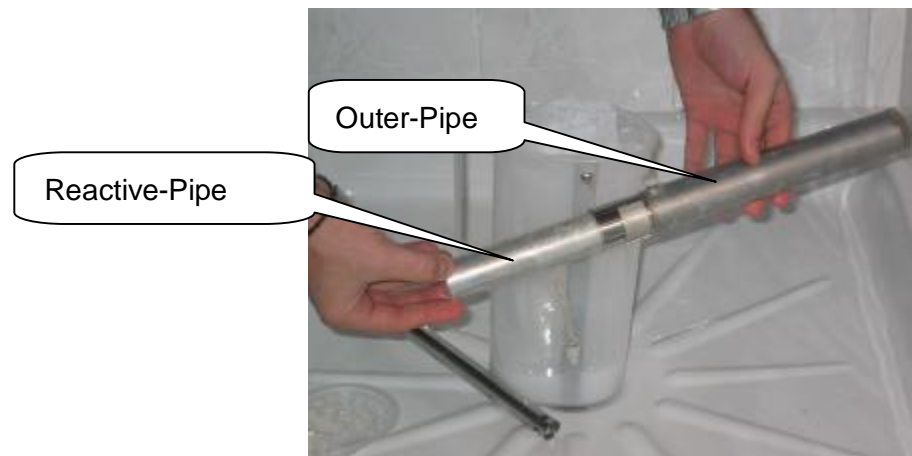

4) Clean up the Outer-Pipe by water.

Inside of Outer-Pipe and outside of Inner-Pipe has to be cleaned by brush.

But, Do not use brush for Outside of Outer-Pipe.

Use soft cloth or hand.



- 5) Clean up Reactor-Pipe by brush and water.
- 6) Clean up Funnel by brush and water.



- 7) Put 1st Filter in 1st Tank and turn the end outside.
Expand inside of the 1st Filter.



- 8) Pour Polish Water to 1st Tank.
Polish Water is needed **approximate 500ml**.
Make it according to standard mixture ratio with Soft Water and "Solution D".



9) Set up all parts as it was before.



10) Set a 1st Tank on 2nd Tank.

Make sure that Terminals have to be connected firmly.



11) Drainage Pipe has to be turned and put into the hole of 2nd Tank.



6.4 Weekly maintenance

It is suggested that it is cleaned to use this machine steadily long.

Especially, clean up **“Splash Cover”** and **“Turn Table”** using soft cloth.

7. Caution



CAUTION! Installation on horizontal surface

Set this machine to the flattest place.



CAUTION! Do not modify

Modification of this machine is strictly prohibited.
This could cause a failure.



CAUTION! Handling of machine

When moving this machine, 1st Tank and 2nd Tank have to be empty.

8. After Service

In the Error occurs often, stop the operation, turn OFF the power switch, and unplug the power plug. Please contact the sales agency that unit was purchased.

<Check following items before contact>

(See the production plate attached to this unit)

Model name of product

Serial Number

About Trouble (in detail as possible)

Error Code

9. Specifications

EDR Series

Model	ECOMaster
CPU	32bit RISC Microprocessor
Operation Panel	320 * 240 dots STN Color-LCD and Touch panel
Operation ambient Temperature range	5 to 35°C
Operation ambient Humidity range	Below 90%
Power supply (50/60Hz)	100VAC to 240VAC, 250W(MAX)
Dimensions (W * D * H mm)	472 * 310 * 1023
Weight	Approx. 64.5Kg

10.Wiring Diagram

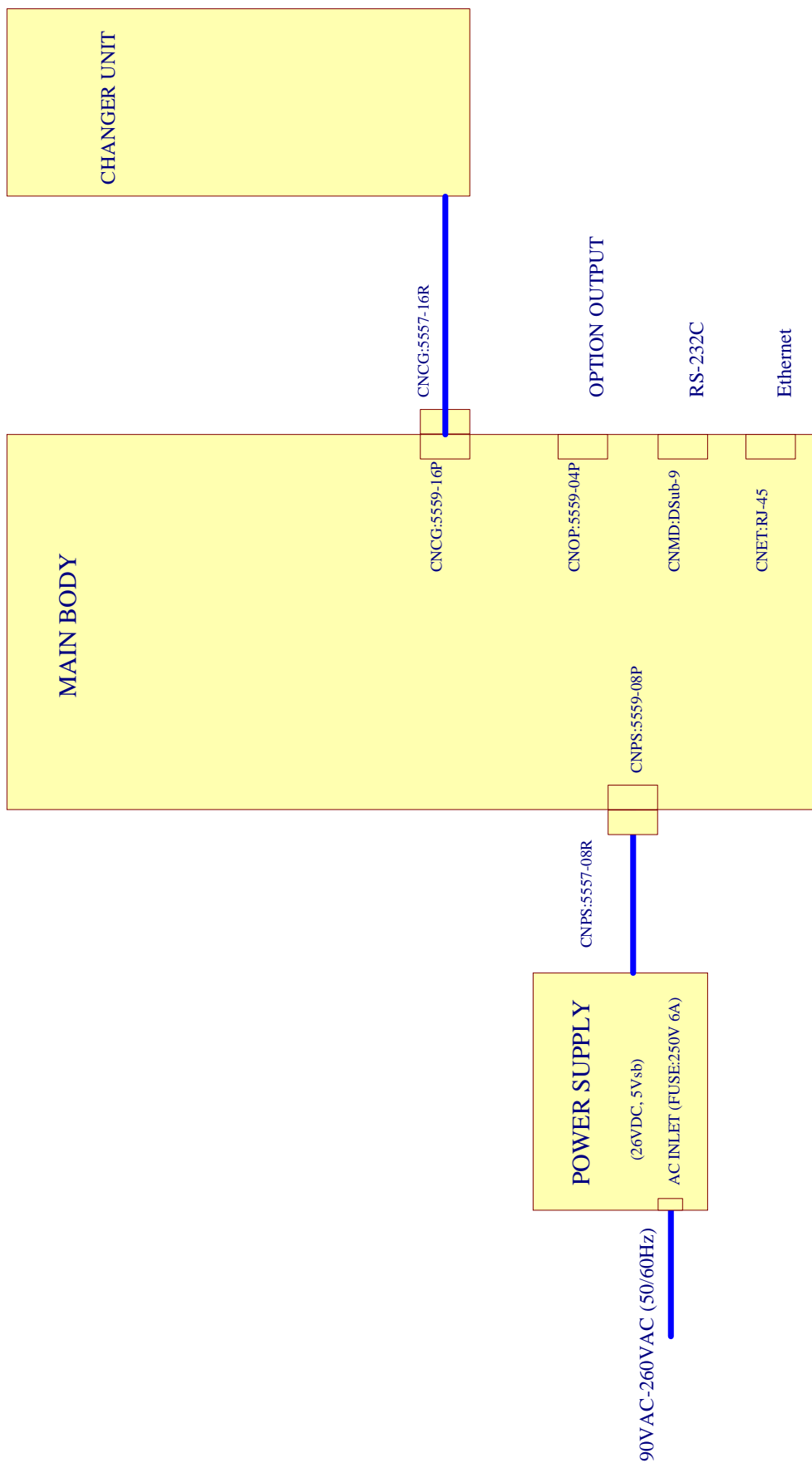

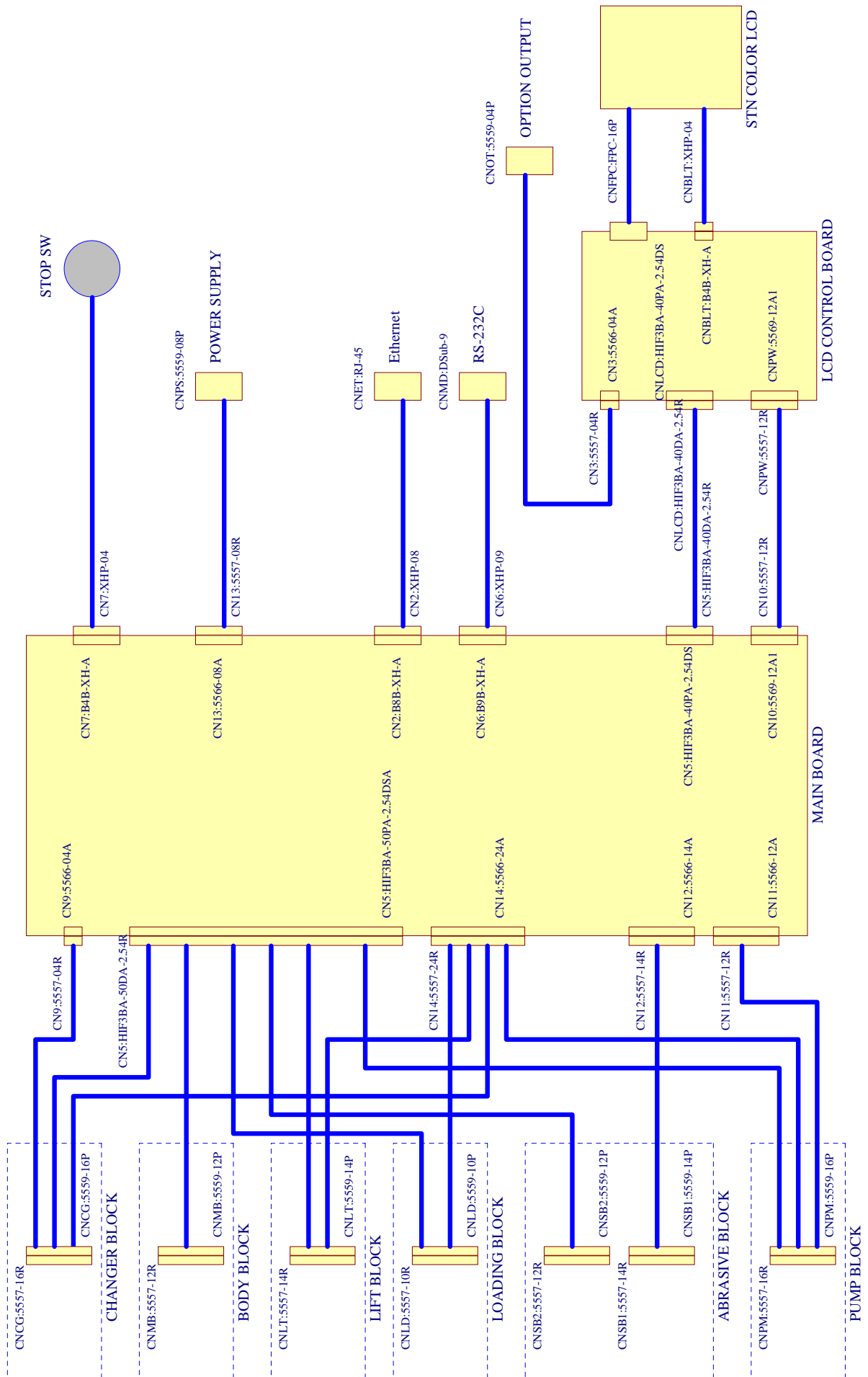

11. Replacement Parts

<Replacement Parts>

Part Name	Code No.	Specification
Center seal	EDR - EM – A31d	
Compound Pump	EM -	
Water Pump	EM -	
Sanding Motor Unit	EM -	
Vacuum Pump	EM -	
Vacuum Filter	EM -	
Vacuum Pad	EM -	

<Consumable Materials>

Part Name	Code No.	Specification
Pad (BLUE)	EDR - EC - 005	
Pad (RED)	EDR - EC - 004	
Pad (GREEN)	EDR - EC - 003	
Pad (YELLOW)	EDR - EC - 002	
Pad (BLACK)	EDR - EC - 001	DIA60mm
Compound	EDR - EC - 006	1box in 6 bottles (750ml)
Solution D	EDR - EC - 007	500ml
Al-Pipe	EDR - EC - 008	L=246mm
1st Filter	EDR - EC - 009	1pack in 20 sheets

12. Warranty

Instruction Manual for

EDR

ECOMaster

Rev 1.0 3, Feb, 2003

Rev 2.0 24, Apr, 2003

Rev 2.1 10, Oct, 2003

ELM Inc.